

The JBL logo is displayed in white, bold, sans-serif capital letters within a solid orange square.

Home Entertainment



FM52, FM62,
FM82, FM65C
& FM8SUB
simple
set-up guide

thank you for choosing JBL. For over 50 years, JBL has been involved in every aspect of musical and film recording and reproduction, from live performances to monitoring the recordings you play in your home, car, or office.

We're confident that the **JBL loudspeakers** you have chosen will provide every note of enjoyment that you expected – and that when you think about purchasing additional audio equipment for your home, car, or office you will once again choose JBL.

Please take a moment to complete the enclosed profile card. It enables us to keep you posted on our latest advancements, and helps us to better understand our customers and build products that meet your needs and expectations.

one. Speaker Placement

FM52, FM62, FM82 as front speakers

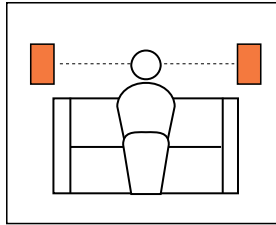
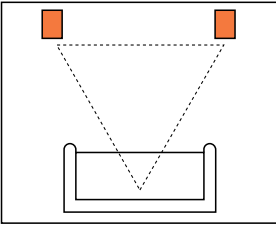

FM52, FM62, FM82 as rear speakers

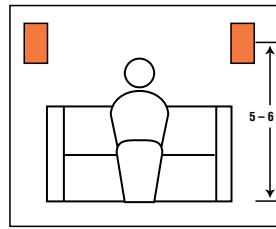
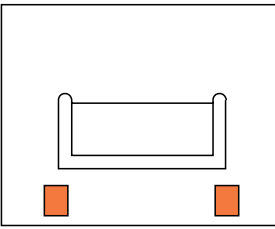

FM65C in ceiling

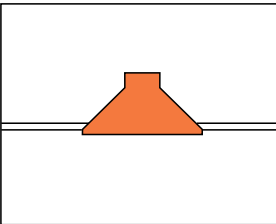

FM8SUB subwoofer in wall

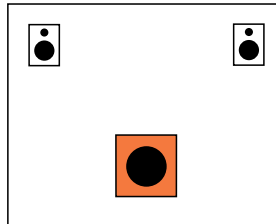

two. Speaker Connections

Connection Tips

Wire Length

Up to 20 ft.
Up to 30 ft.
Greater than 30 ft.

Recommended Size

16 gauge
12 gauge
10 gauge

The wires for both speakers should be the same length. If one speaker is placed closer to the amplifier than the other, hide the excess wire behind the wall.

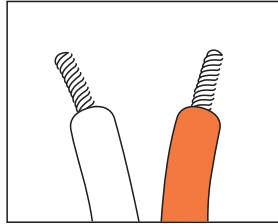

Speakers and electronics terminals have corresponding (+) and (-) terminals. It is important to connect both speakers identically: (+) on the speaker to (+) on the amplifier and (-) on the speaker to (-) on the amplifier. Wiring “out of phase” results in thin sound, weak bass and a poor stereo image.

FM52, FM62, FM82, FM65C

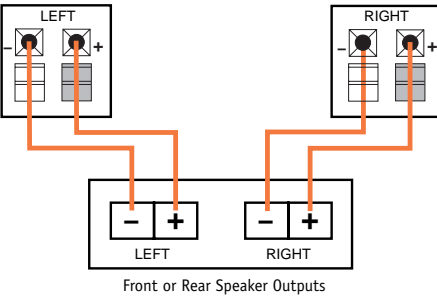

FM8SUB

The FM8SUB has two speaker connections. Connect one set of terminals, along with your left

satellite to the left channel of your amplifier. Connect the other set of terminals, along

with your right satellite to the right channel of your amplifier.

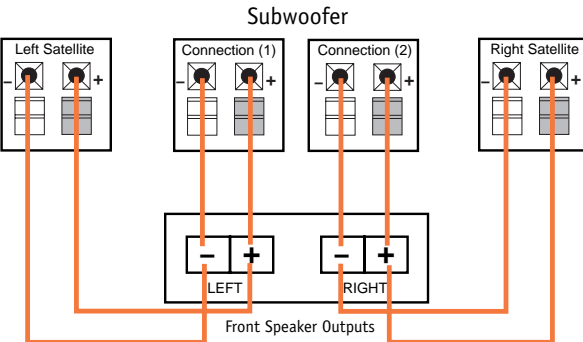

three. **Installation**

The FM Series flush-mount speakers were designed to be easily installed. However, if you are unsure of your ability to

properly install these loudspeakers, please contact your dealer or a qualified installer.

Tools Needed

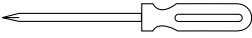

Phillips #2 screwdriver

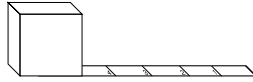

Measuring tape



Utility knife



Pencil

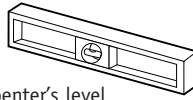

Carpenter's level

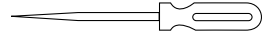

Awl

FM52, FM62, FM82

Installation Kit

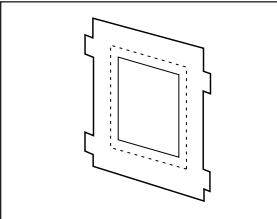

Template

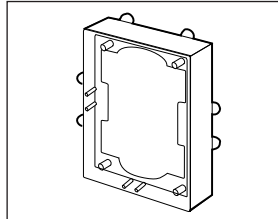

Speaker frame

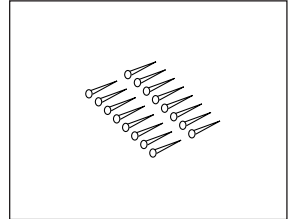

Thread-forming screws

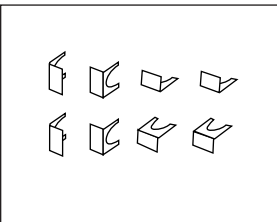

Retainer clips

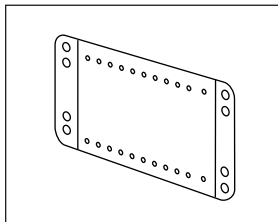

Mounting brackets

Existing Construction

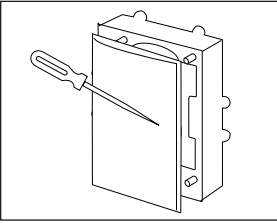

Step One:
Remove the grille from the speaker frame.

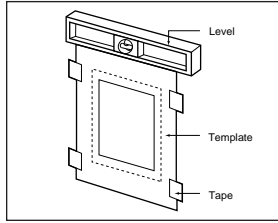

Step Two:
Determine the correct speaker location.

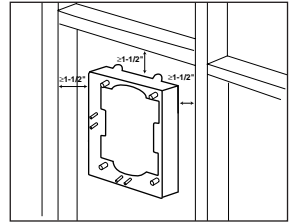

Step Three:
Determine the speaker-frame location.

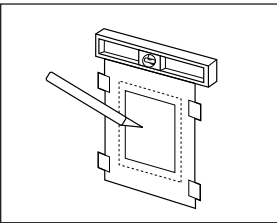

Step Four:
Cut the dry wall.

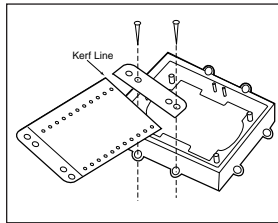

Step Five:
Place the mounting bracket on the speaker frame using the mounting guides (marked 3/8", 1/2", 5/8", and 3/4") corresponding to the thickness of the dry wall.

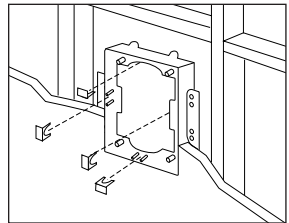

Step Six:
Place the frame assembly in the wall.

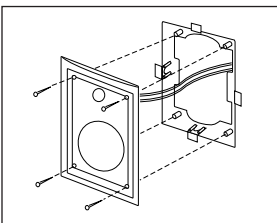

Step Seven:
Connect the speaker wires to the baffle assembly and install baffle assembly in frame. **Do not overtighten the baffle screws.**

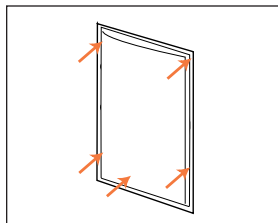

Step Eight:
Replace the metal grille.

New Construction

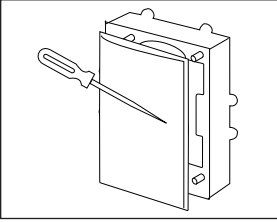

Step One:

Remove the grille from the speaker frame.

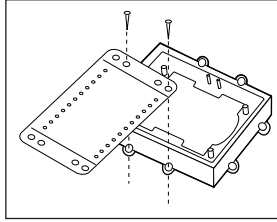

Step Two:

Attach the proper mounting bracket, marked and preset at 3/8", 1/2", 5/8", and 3/4" to the speaker frame.

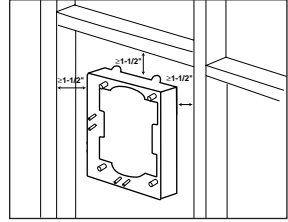

Step Three:

Determine the correct speaker location.

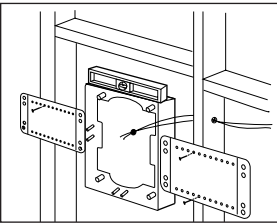

Step Four:

Nail or screw the speaker frame assembly to the wall studs and route the wires through the frame opening.

After the Drywall is Installed

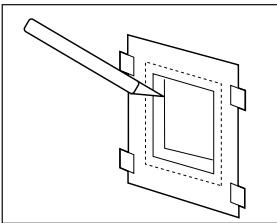

Step Five:

Cut the drywall.

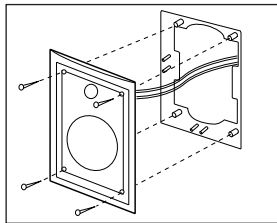

Step Six:

Connect the speaker wires to the baffle assembly and install baffle assembly in frame. **Do not overtighten the baffle screws.**

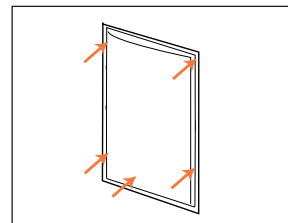

Step Seven:

Replace the metal grille.

FM8SUB

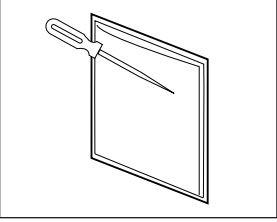

Step One:
Remove the grille from the subwoofer frame.

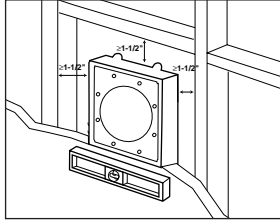

Step Two:
Determine the correct subwoofer location.

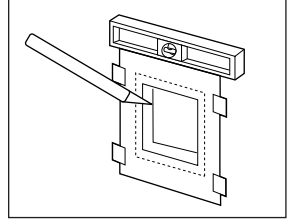

Step Three
Cut the drywall.

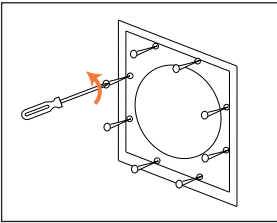

Step Four:
Loosen the eight phillips head screws until the locking tabs turn inward.

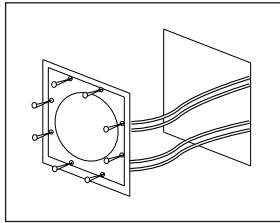

Step Five
Connect the speaker wires to the baffle assembly.

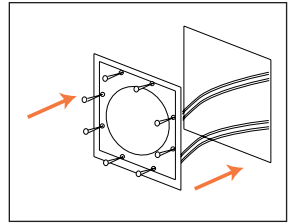

Step Six:
Place the subwoofer in the wall.

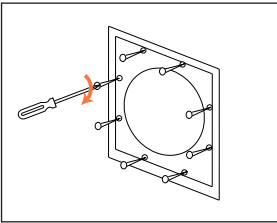

Step Seven:
Screw down each of the eight phillips head screws. The tabs will swivel into place and secure the unit to the rear surface of the drywall.

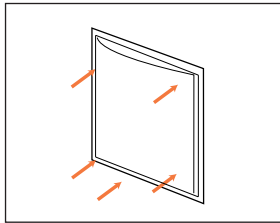

Step Eight
Replace the metal grille.

FM65CX

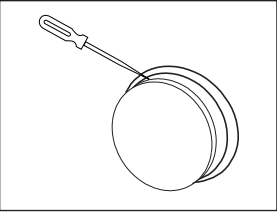

Step One:
Remove the grille from the speaker frame.

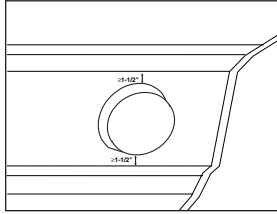

Step Two:
Determine the correct speaker location in the ceiling.

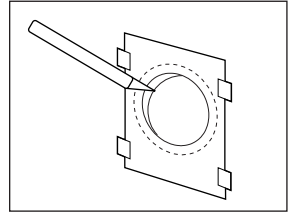

Step Three:
Cut the drywall.

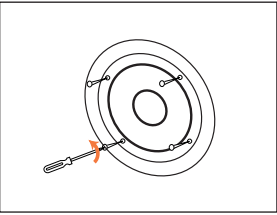

Step Four:
Remove 4 phillips head screws that attach speaker to frame.

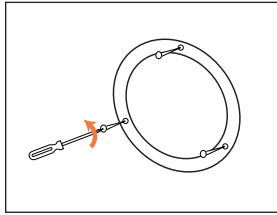

Step Five:
Loosen the three phillips head screws on the frame, until the locking tabs turn inward.

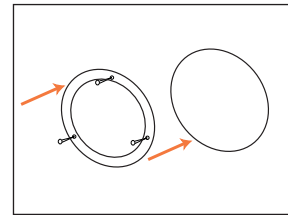

Step Six:
Place the frame assembly in the wall.

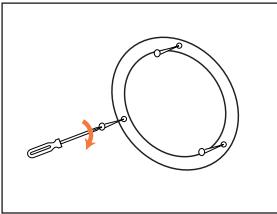

Step Seven:
Screw down each of the three phillips head screws. The tabs will swivel into place and secure the unit to the rear surface of the drywall.

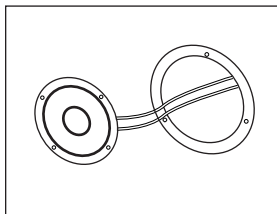

Step Eight:
Connect the speaker wires to the speaker.

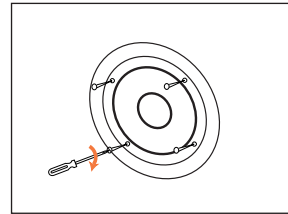

Step Nine:
Reinstall speaker in frame, using 4 phillips head screws.

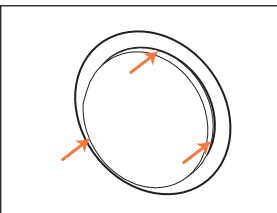

Step Ten:
Replace the metal grille.

Painting the Speaker Frame and Grille

FM Series loudspeakers can be painted to match any style of decor. If you wish to change their color, the satin finish on the grille and frame will function as a primer coat. Before painting install the paint guard (in the assembly kit) securely into the recess in the baffle.

This will protect the speaker components and baffle from paint residue. Use a high-quality spray paint, and apply a thin coat of color. **Be certain the grille perforations remain free of paint. Filling them with paint will diminish the sound quality.**

Note: Gently remove the acoustical blanket from the back of the grille before painting. Reattach the acoustical blanket after the paint has dried.

Troubleshooting

If there is no sound from either of the speakers, check the following:

- Receiver/amplifier is on and a source is playing.
- Check all wires and connections between receiver/amplifier, in-wall room volume control and speakers. Make sure all wires are connected. Make sure none of the speaker wires are frayed, cut, or punctured.
- Review proper operation of your receiver/amplifier.

If there is no sound coming from one speaker, check the following:

- Check the "Balance" control on your receiver/amplifier.
- Check all wires and connections between receiver/amplifier, and speakers. Make sure all wires are connected. Make sure none of the speaker wires are frayed, cut, or punctured.

If there is low bass output, check the following:

- Make sure the connections to the left and right "Speaker Inputs" have the correct polarity (+ and -).

If the system plays at low volumes but shuts off as volume is increased, check the following:

- Check all wires and connections between receiver/amplifier and speakers. Make sure all wires are connected. Make sure none of the speaker wires are frayed, cut, or punctured.
- If more than one pair of main speakers is being used, check the minimum impedance requirements of your receiver/amplifier.

Specifications

SYSTEM	FM52	FM62	FM65C
Frequency Response (-6dB):	50Hz – 20kHz	40Hz – 20kHz	45Hz – 20kHz
Recommended Maximum Amplifier Power*:	40 watts	50 watts	50 watts
Sensitivity:	88dB	90dB	90dB
Impedance:	8 ohms nominal	8 ohms nominal	8 ohms nominal
Crossover Frequency:	6kHz	5kHz	7kHz
Woofers:	5-1/4"	6-1/2"	6-1/2"
Tweeters:	1" titanium	1" titanium	1" titanium
Outside Dimensions (HxW):	11 x 7-1/2 inches 280 x 190mm	13 x 7-1/2 inches 330 x 190mm	8-1/8 inches (dia.) 206mm (dia.)

SYSTEM	FM82	FM8SUB
Frequency Response (-6dB):	35Hz – 20kHz	32Hz – 300Hz
Recommended Maximum Amplifier Power*:	60 watts	120 watts
Sensitivity:	88dB	88dB
Impedance:	8 ohms	8 ohms
Crossover Frequency:	5kHz	300Hz
Woofers:	8"	8"
Tweeters:	1" titanium	N/A
Outside Dimensions (HxW):	15-1/8 x 11 inches 385 x 280mm	11-13/16 x 11-13/16 inches 300 x 300mm

Occasional refinements may be made to existing products without notice, but will always meet or exceed original specifications unless otherwise stated.

*The maximum recommended amplifier power rating will ensure proper system headroom to allow for occasional peaks. We do not recommend sustained operation at these maximum power levels.



Home Entertainment

JBL Incorporated
8500 Balboa Boulevard, Northridge, CA 91329
1-800-336-4JBL (4525) (USA only)

© 1996 JBL, Incorporated.
JBL is a registered trademark of JBL, Incorporated.
Printed in USA 7/96  Part No. FMOM

harman consumer group www.harman.com

Declaration of Conformity



We, JBL Europe A/S
Kongevejen 194B
DK-3460 Birkerød
DENMARK

declare in own responsibility, that the products described
in this owner's manual are in compliance with technical
standards:

EN 50 081-1/1992
EN 50 082-1/3.1995

Steen Michaelsen
JBL Europe A/S
Birkerød, DENMARK, 7/96